

**JUNQUAN**<sup>®</sup>  
JUNQUAN AUTOMATION  
— 君权自动化 —

# 产品说明书

Product Specifications

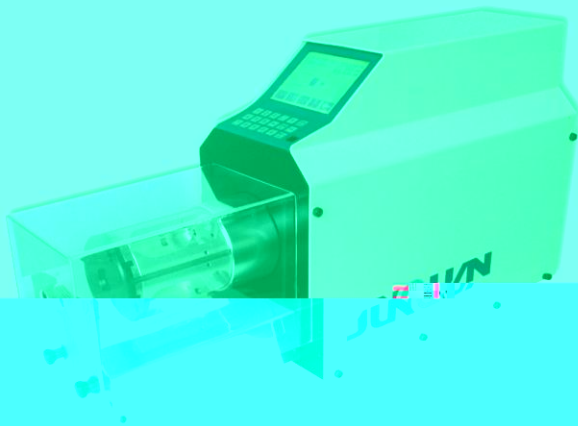

**ZDBX-39R**

**同轴电缆剥皮机**

浙江君权自动化设备有限公司  
ZHEJIANG JUNQUAN AUTOMATION EQUIPMENT CO., LTD.



1 AC220V±10%,50Hz

2

3

4

5

---



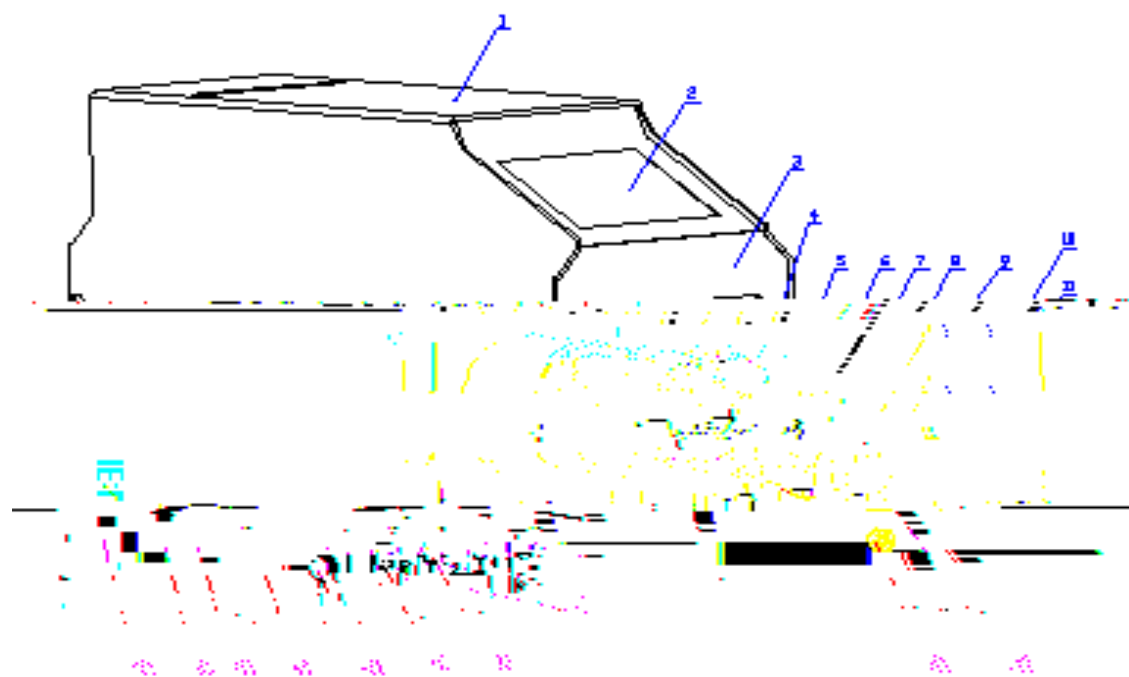

触摸显示屏	3. 前面板
旋刀体	6. 刀架内滑座
刀片	9. 中心定位片
线夹	12. 夹线摆杆
线夹传动轴	15. 夹线导轨轴
传动轴支架	18. 定位片安装架
手柄螺丝	21. 夹线撑挡

1. 机箱	2.
4. 旋刀体固定螺丝	5.
7. 刀架外滑座	8.
10. 线夹固定架	11.
13. 线夹导轨支臂	14.
16. 夹线滑动销轴	17.
19. 刀片安装架	20.



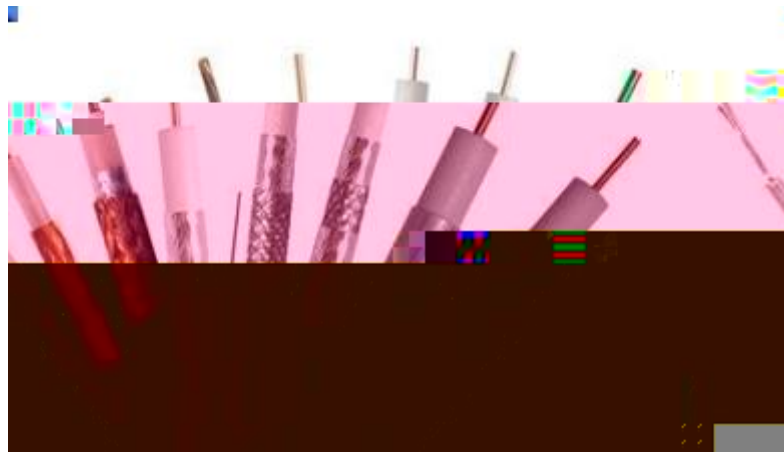

	<div style="background-color: black; height: 20px; width: 100%;"></div>
	<div style="background-color: black; height: 20px; width: 100%;"></div>
	<div style="background-color: black; height: 20px; width: 100%;"></div>

	<div style="background-color: black; height: 20px; width: 100%;"></div>
	<div style="background-color: black; height: 20px; width: 100%;"></div>
	<div style="background-color: black; height: 20px; width: 100%;"></div>

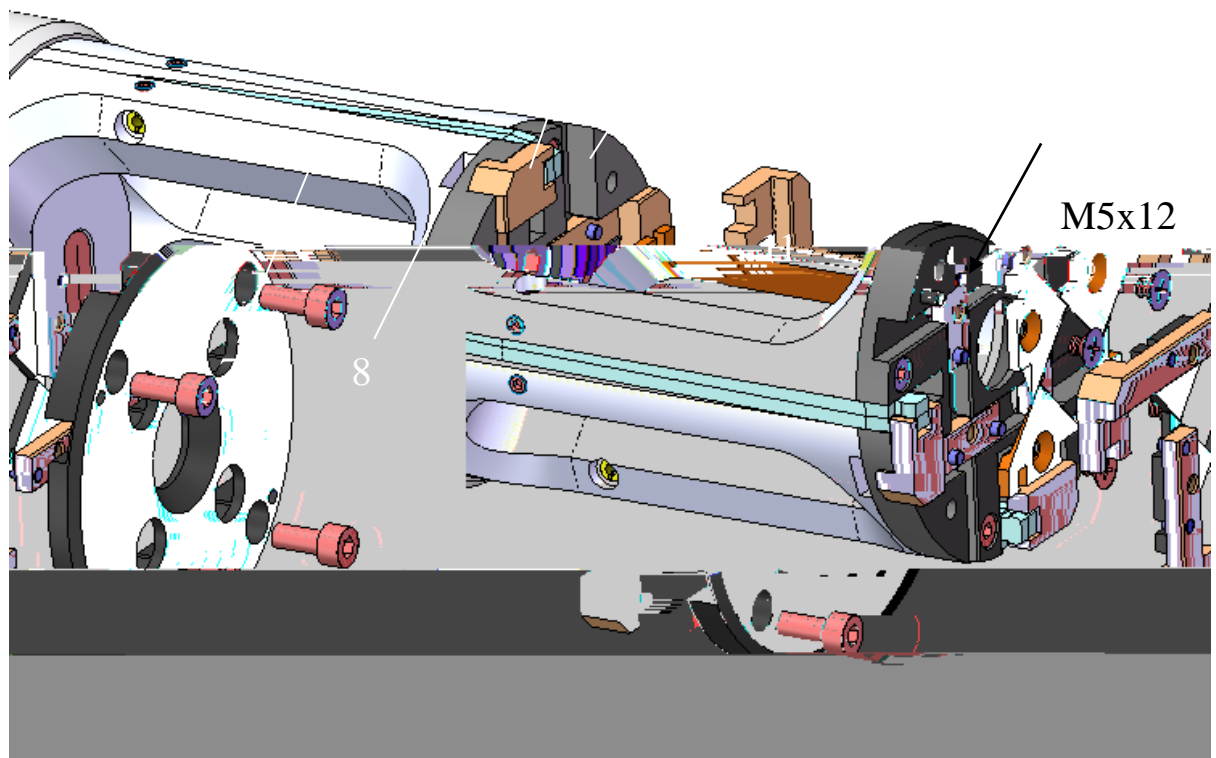

- 1
- 2     4    M5x12
- 3
- 4
5.                    M4x5
6.    M4x5                    M5x12





1 9

2.

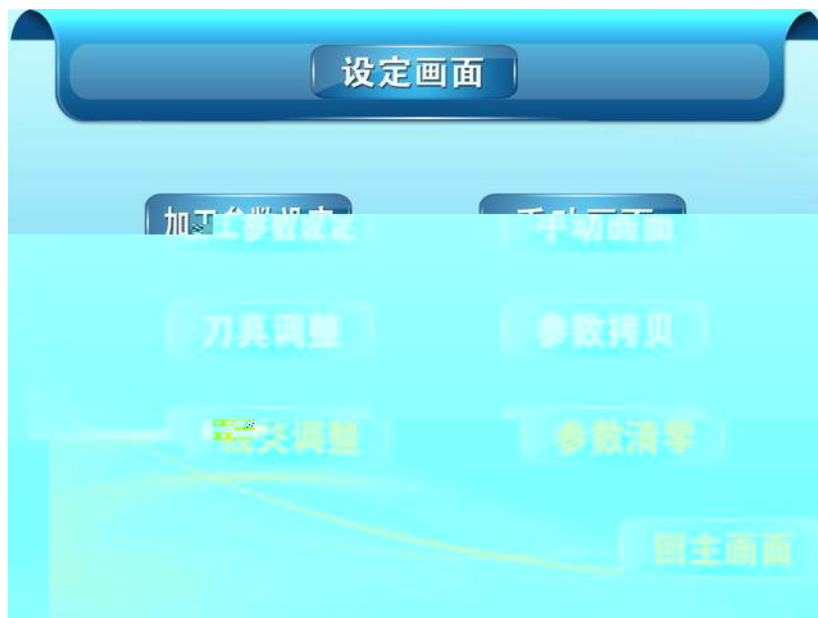

3.

1



0.01mm



2

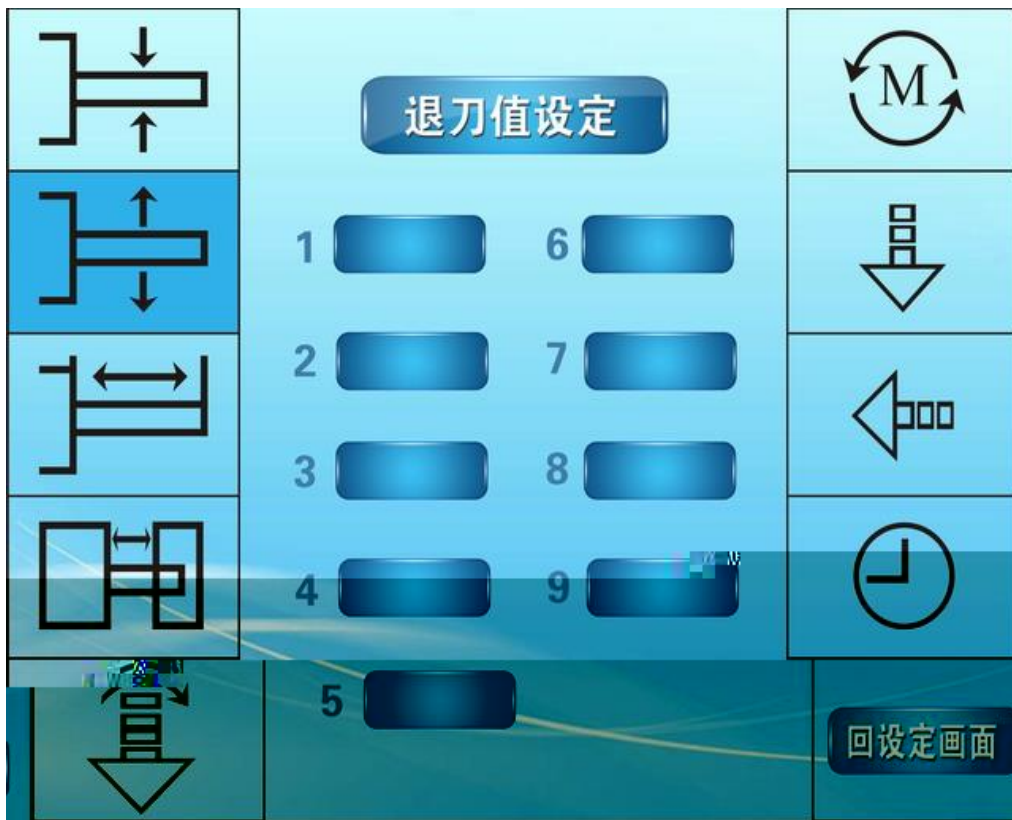

3

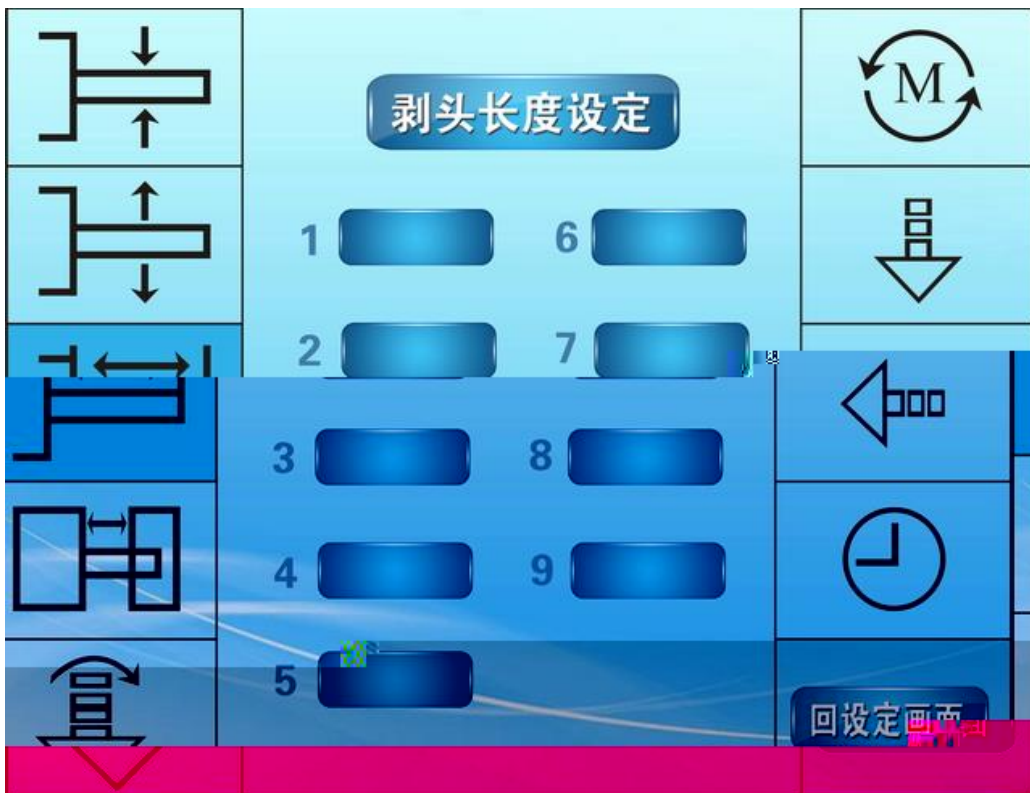

4

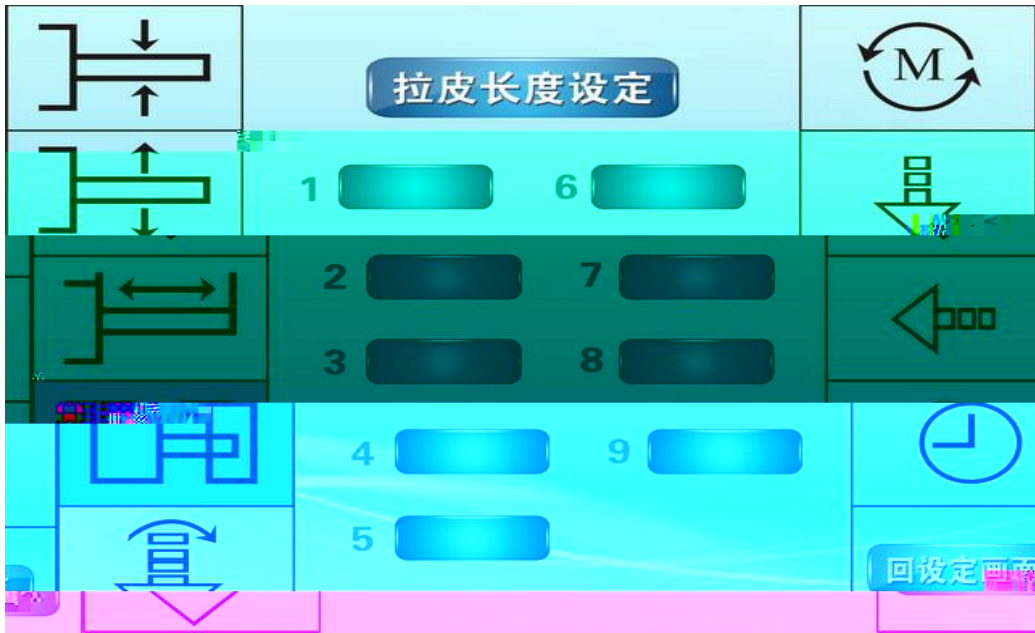

5



0

1

2

3

6

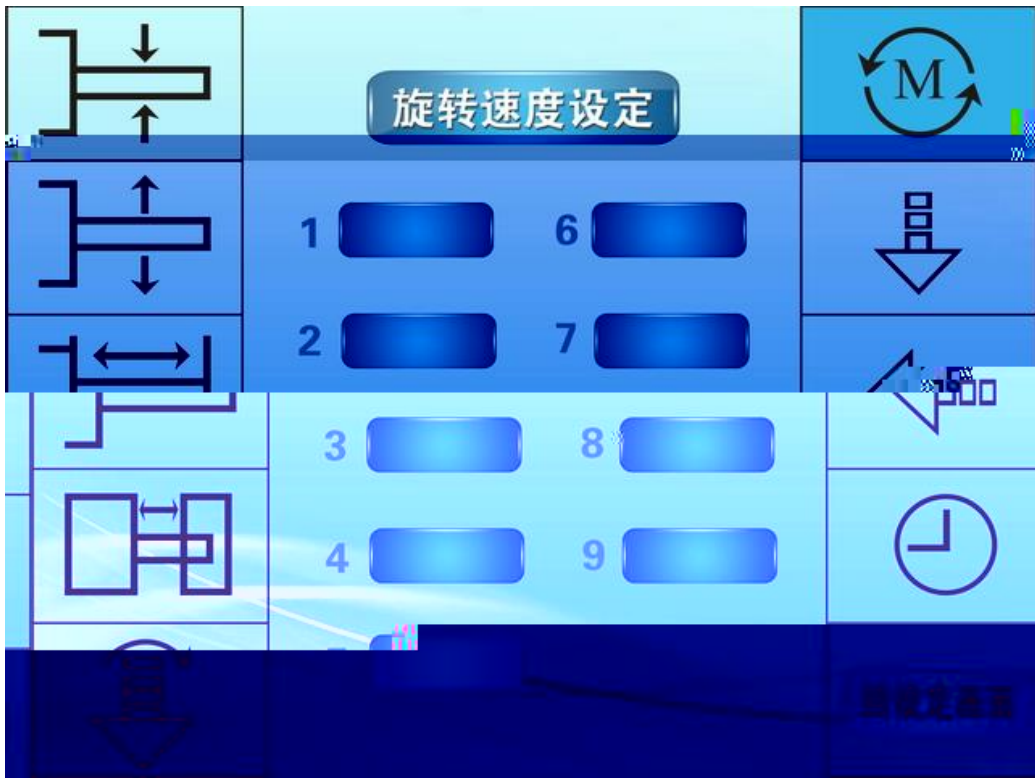

7

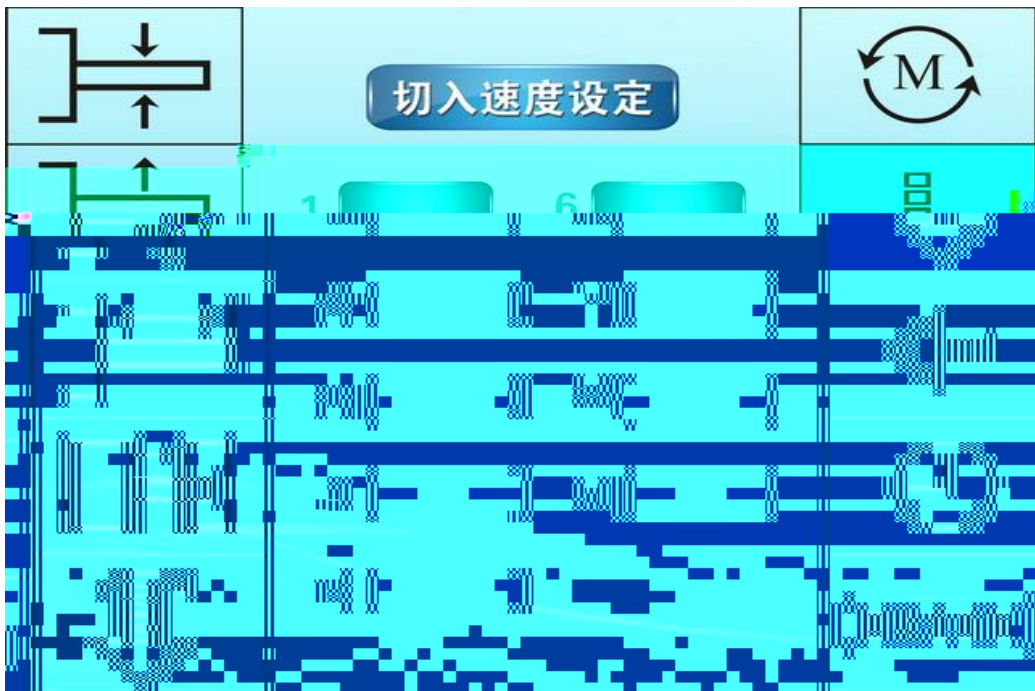

8



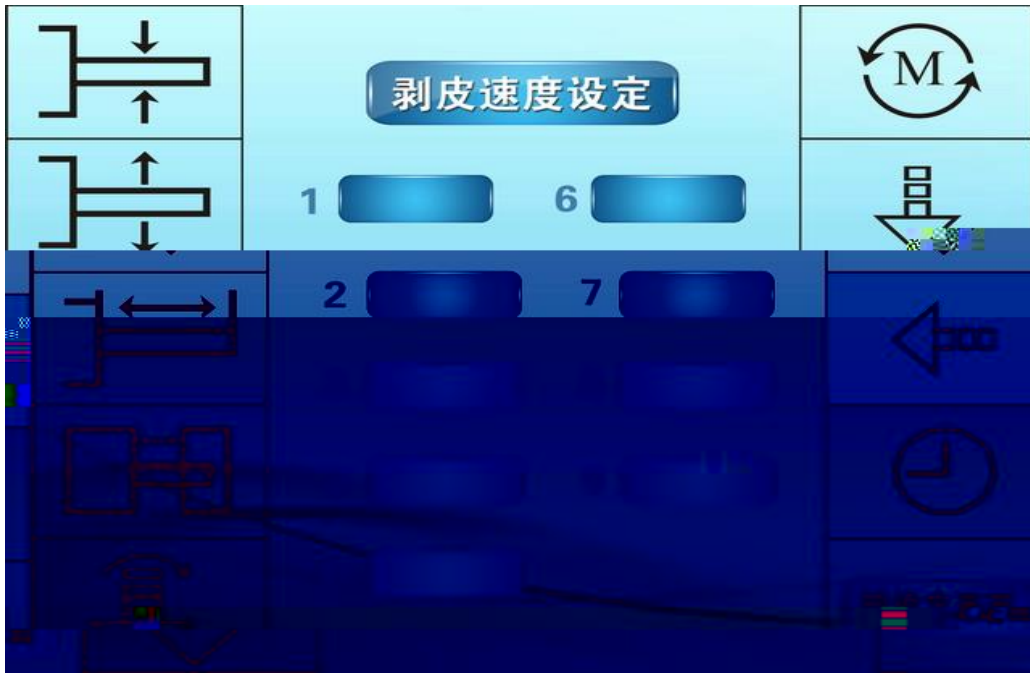

9



0	1	2	3	4	5	6	7	8	9
50ms	150ms	190ms	250ms	300ms	360ms	430ms	990ms	1120ms	1240ms

4.

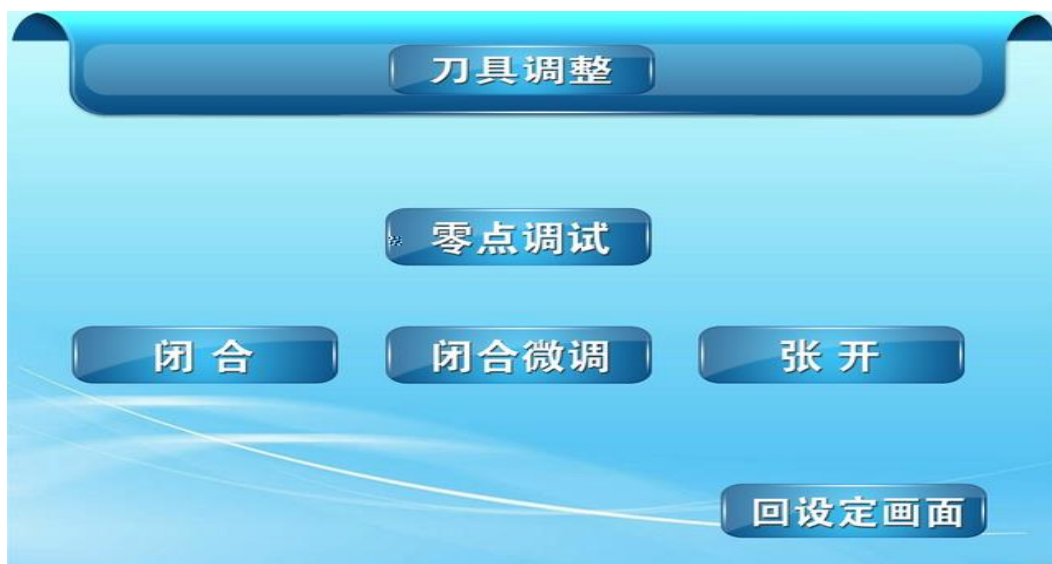

5.



6.



1

2

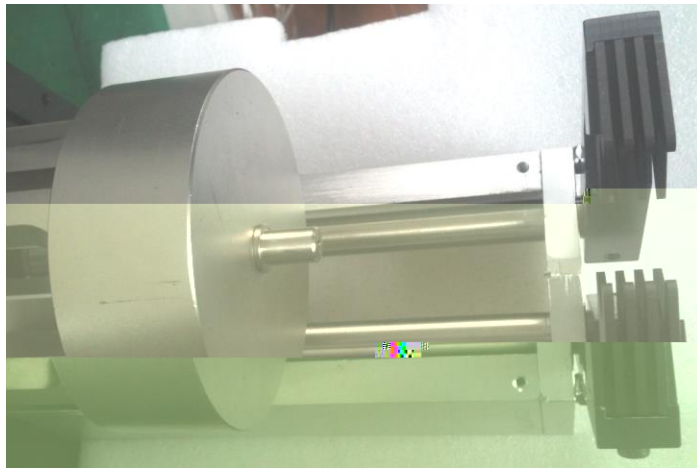

3



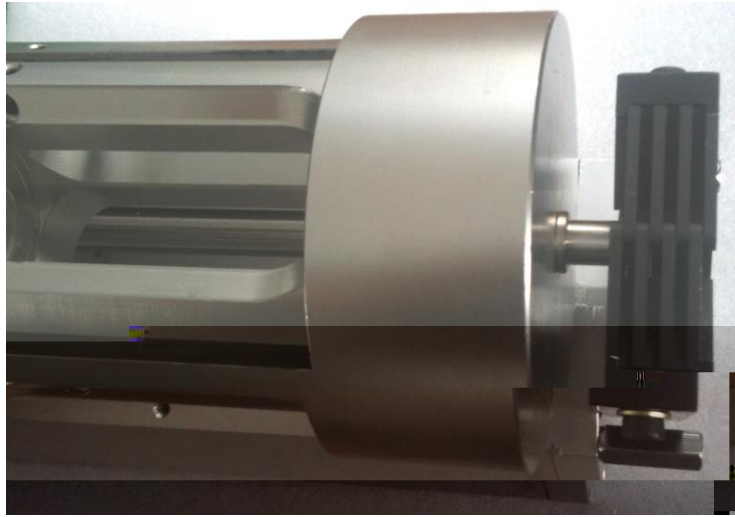

4



**0573-82331888 82330999**

**www.junquan.com**

/Tel 0086-577-62900000 62901111 82199999

/Fax 0086-577-62902918 62902199

E-mail: junquan@wz.zj.cn

586

/Tel 0086-573-82331888 82330999

/Fax 0086-573-82301199

586

Tel 0573-82331888 82330999

Tel 0577-62900000 62901111

B 1518

Tel 0371-56608999 63953399

782

607

Tel 0755-89638399 89637269

C 17 6/2

Tel 023-67305528 67305527

---